



International
Organization for
Standardization



2019
collection

www.avitaseramik.com.tr



International
Organization for
Standardization



◇ hela taşı

10
YIL GARANTİ
YEAR WARRANTY

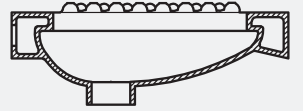
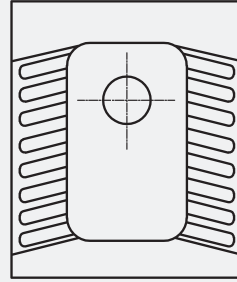

İçten Yıkamalı
Hela Taşı

Kodu	Ürün	Palet Ad.
1200	İçten Yıkamalı Hela Taşı	30



www.avitaseramik.com.tr



International
Organization for
Standardization

10
YIL GARANTİ
YEAR WARRANTY

hela taşı ◊

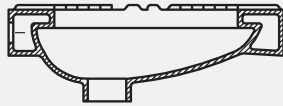
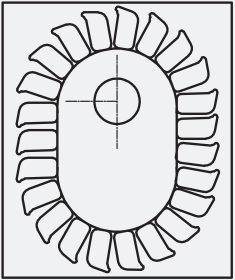

Kodu	Ürün	Palet Ad.
1400	Güneş Çevre Yıkamalı Hela Taşı	30

Güneş
Çevre Yıkamalı
Hela Taşı



International
Organization for
Standardization

◇ beta

10
YIL GARANTİ
YEAR WARRANTY

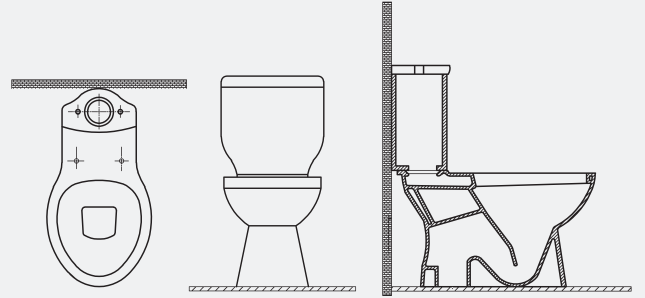

Beta Klozet + Rezervuar

Alttan Çıkışlı

Kodu	Ürün	Palet Ad.
2200	Beta Klozet + Rezervuar Takımı	13



www.avitaseramik.com.tr



International
Organization for
Standardization

beta ◊

10
YIL GARANTİ
YEAR WARRANTY

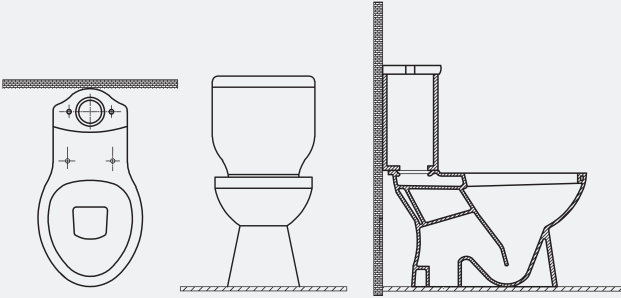

Kodu	Ürün	Palet Ad.
2210	Beta Klozet + Rezervuar Takımı	13

Beta Klozet + Rezervuar

Arkadan Çıkışlı



International
Organization for
Standardization

7



◇ arsemia

10
YIL GARANTİ
YEAR WARRANTY

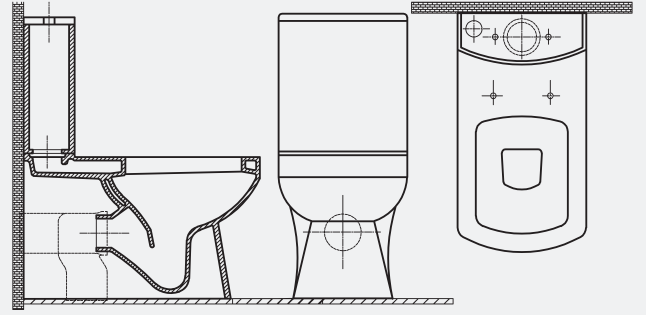

Arsemia Klozet + Rezervuar

Alttan Çıkışlı

Kodu	Ürün	Palet Ad.
2400	Arsemia Klozet + Rezervuar Takımı	13



www.avitaseramik.com.tr



International
Organization for
Standardization

10
YIL GARANTİ
YEAR WARRANTY

cosmo ◊

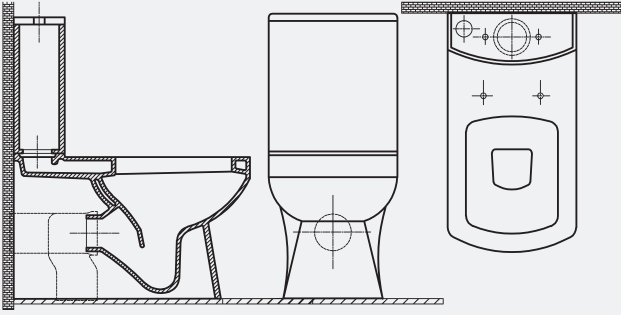

Kodu	Ürün	Palet Ad.
2300	Cosmo Klozet + Rezervuar Takımı	10

Cosmo Klozet + Rezervuar



International
Organization for
Standardization

◇ alfa

10
YIL GARANTİ
YEAR WARRANTY

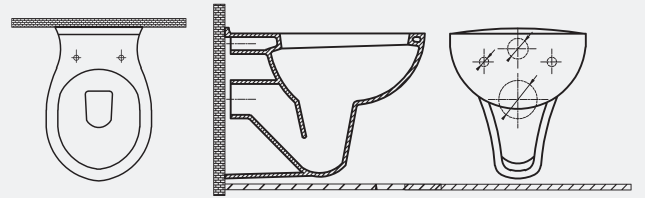

Alfa Asma Klozet

Kodu	Ürün	Palet Ad.
3000	Alfa Asma Klozet	15



www.avitaseramik.com.tr



International
Organization for
Standardization

10
YIL GARANTİ
YEAR WARRANTY

arsemia ◊

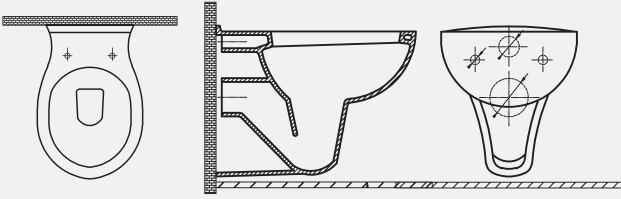

Kodu	Ürün	Palet Ad.
3100	Arsemia Asma Klozet	15

Arsemia
Asma Klozet



International
Organization for
Standardization

◇ nemrut

10
YIL GARANTİ
YEAR WARRANTY

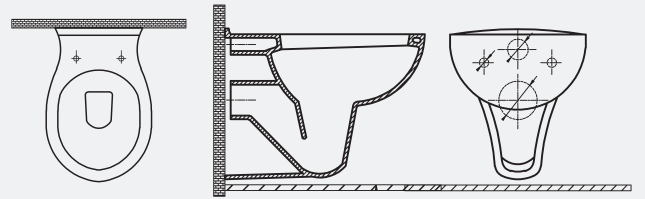

Nemrut Asma Klozet

Kodu	Ürün	Palet Ad.
3200	Nemrut Asma Klozet	10



www.avitaseramik.com.tr



International
Organization for
Standardization

bicir ◊

10
YIL GARANTİ
YEAR WARRANTY

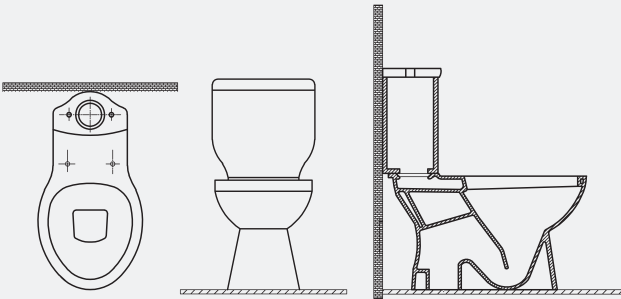

Kodu	Ürün	Palet Ad.
2700	Bicir Çocuk Klozet + Rezervuar	10

Bicir
Çocuk Klozet
+ Rezervuar



International
Organization for
Standardization

◇ beta

10
YIL GARANTİ
YEAR WARRANTY

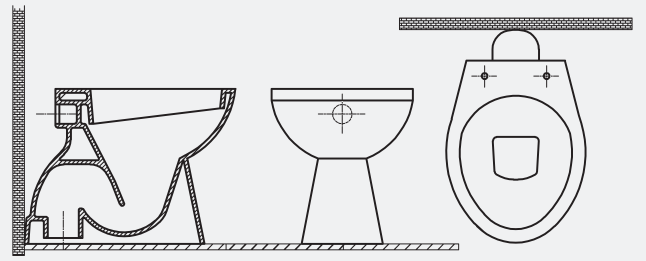

Beta (Universal) Arkadan Çıkışlı Tek Klozet

Kodu	Ürün	Palet Ad.
2600	Beta (Universal) Arkadan Çıkışlı Tek Klozet	18



www.avitaseramik.com.tr



International
Organization for
Standardization

beta ◊

10
YIL GARANTİ
YEAR WARRANTY

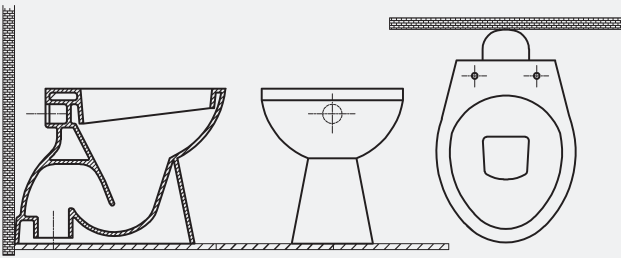

Kodu	Ürün	Palet Ad.
2500	Beta Tek Klozet	18

Beta
Tek Klozet



International
Organization for
Standardization

◇ perre

10
YIL GARANTİ
YEAR WARRANTY

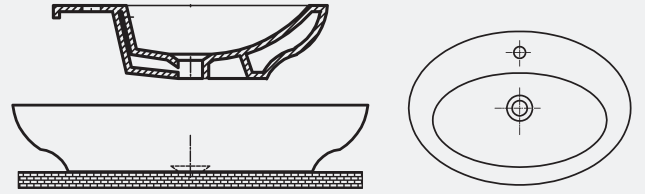

Perre 28x36 Lavabo

Kodu	Ürün	Palet Ad.
1600	Perre 28x36cm Lavabo	10
1610	Perre 28x36cm Delikli Lavabo	10



www.avitaseramik.com.tr



International
Organization for
Standardization

10
YIL GARANTİ
YEAR WARRANTY

perre ◊

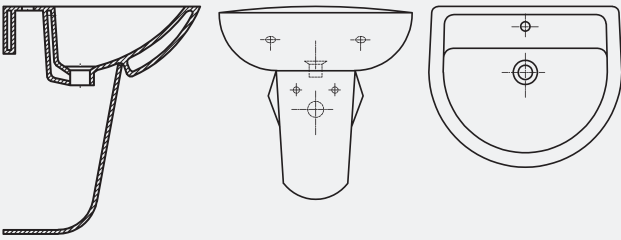

Kodu	Ürün	Palet Ad.
1620	Perre 36x45cm Lavabo	10

Perre
36x45 Lavabo



International
Organization for
Standardization

◇ perre

10
YIL GARANTİ
YEAR WARRANTY

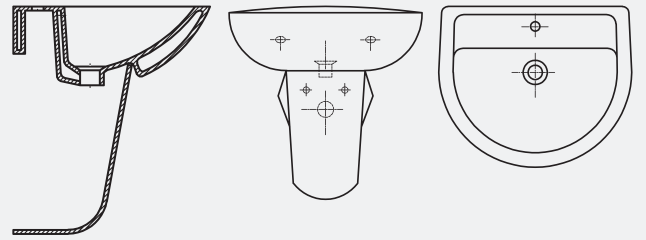

Perre 40x50 Lavabo

Kodu	Ürün	Palet Ad.
1630	Perre 40x50cm Lavabo	10



www.avitaseramik.com.tr



International
Organization for
Standardization

10
YIL GARANTİ
YEAR WARRANTY

perre ◊

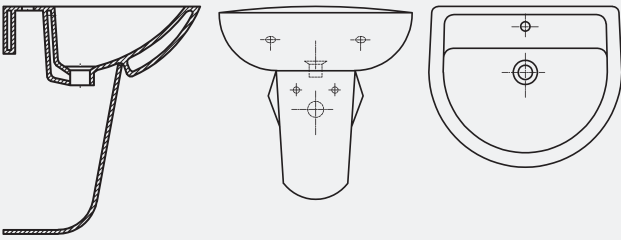

Kodu	Ürün	Palet Ad.
1640	Perre 45x55cm Lavabo	10

Perre
45x55 Lavabo



International
Organization for
Standardization

◇ perre

10
YIL GARANTİ
YEAR WARRANTY

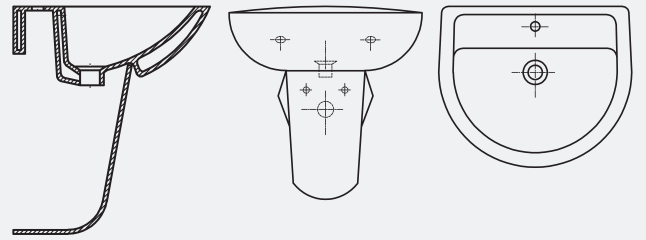

Perre 50x60 Lavabo

Kodu	Ürün	Palet Ad.
1650	Perre 50x60cm Lavabo	10



www.avitaseramik.com.tr



International
Organization for
Standardization

10
YIL GARANTİ
YEAR WARRANTY

aksesuarlar ◊

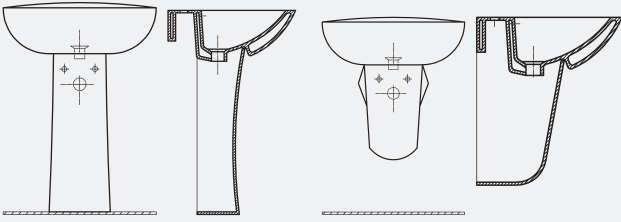

Kodu	Ürün	Palet Ad.
1660	Beta Kolon Ayak	18
1670	Beta Yarım Ayak	18

Beta
Kolon ve Yarım
Ayak



International
Organization for
Standardization

◇ etajerli lavabo

10
YIL GARANTİ
YEAR WARRANTY



Güneş Etajerli Lavabo

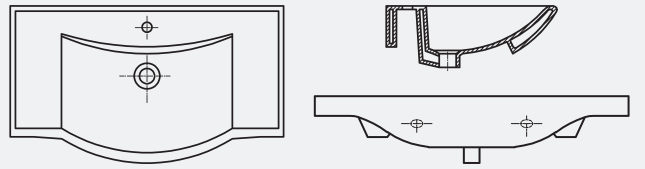

Kodu	Ürün	Palet Ad.
1030	Güneş Etajerli Lavabo 65cm	14
1040	Güneş Etajerli Lavabo 80cm	14
1050	Güneş Etajerli Lavabo 100cm	12



www.avitaseramik.com.tr



International
Organization for
Standardization

perreo

10
YIL GARANTİ
YEAR WARRANTY

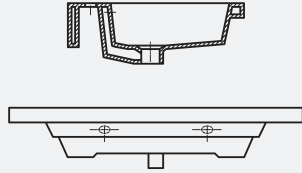
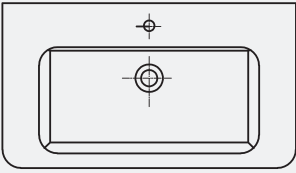

Kodu	Ürün	Palet Ad.
1060	Perre Etajerli Lavabo 65cm	14
1070	Perre Etajerli Lavabo 80cm	14
1080	Perre Etajerli Lavabo 100cm	12

Perre Etajerli Lavabo



International
Organization for
Standardization

◇ lavabolar

10
YIL GARANTİ
YEAR WARRANTY

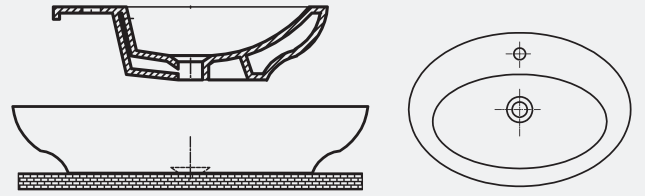

Cosmo Tezgah Altı Lavabo

Kodu	Ürün	Palet Ad.
1010	Cosmo 37x47cm Tezgah Altı Lavabo	24
1020	Cosmo 39x51cm Tezgah Altı Lavabo	20



www.avitaseramik.com.tr



International
Organization for
Standardization

10
YIL GARANTİ
YEAR WARRANTY

perreo

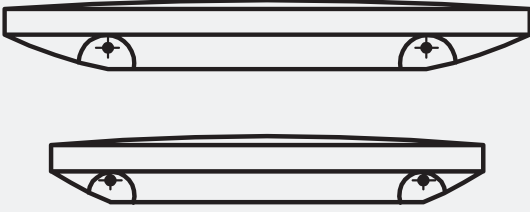

Kodu	Ürün	Palet Ad.
1730	Perre Etajer 10x50cm	200
1740	Perre Etajer 15x50cm	200

Perre Etajer



International
Organization for
Standardization

◇ perre

10
YIL GARANTİ
YEAR WARRANTY

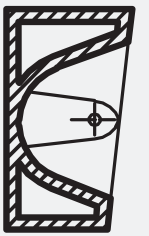
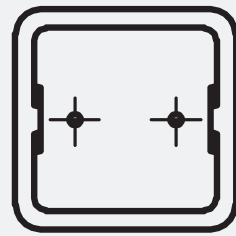

Perre Kollu Sabunluk

Kodu	Ürün	Palet Ad.
1760	Perre Kollu Sabunluk	250



www.avitaseramik.com.tr



International
Organization for
Standardization

10
YIL GARANTİ
YEAR WARRANTY

perre ◊

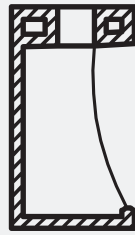
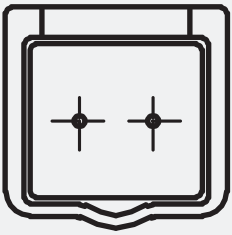

Kodu	Ürün	Palet Ad.
1750	Perre Kağıtlık	250

Perre Kağıtlık



International
Organization for
Standardization

◇ perre

10
YIL GARANTİ
YEAR WARRANTY

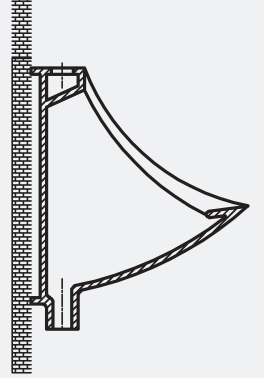
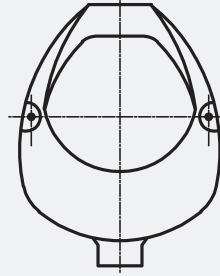

Perre Pisuvar

Kodu	Ürün	Palet Ad.
1710	Perre Pisuvar	24



www.avitaseramik.com.tr



International
Organization for
Standardization

10
YIL GARANTİ
YEAR WARRANTY

perre◇

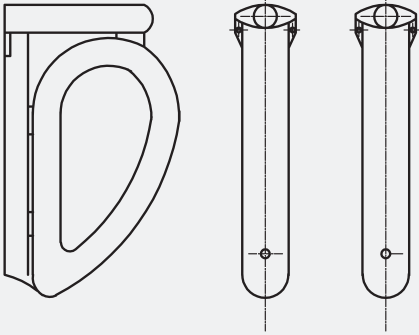

Kodu	Ürün	Palet Ad.
1720	Perre Pisuvar Ara Bölme	24

Perre Pisuvar Ara Bölme



International
Organization for
Standardization

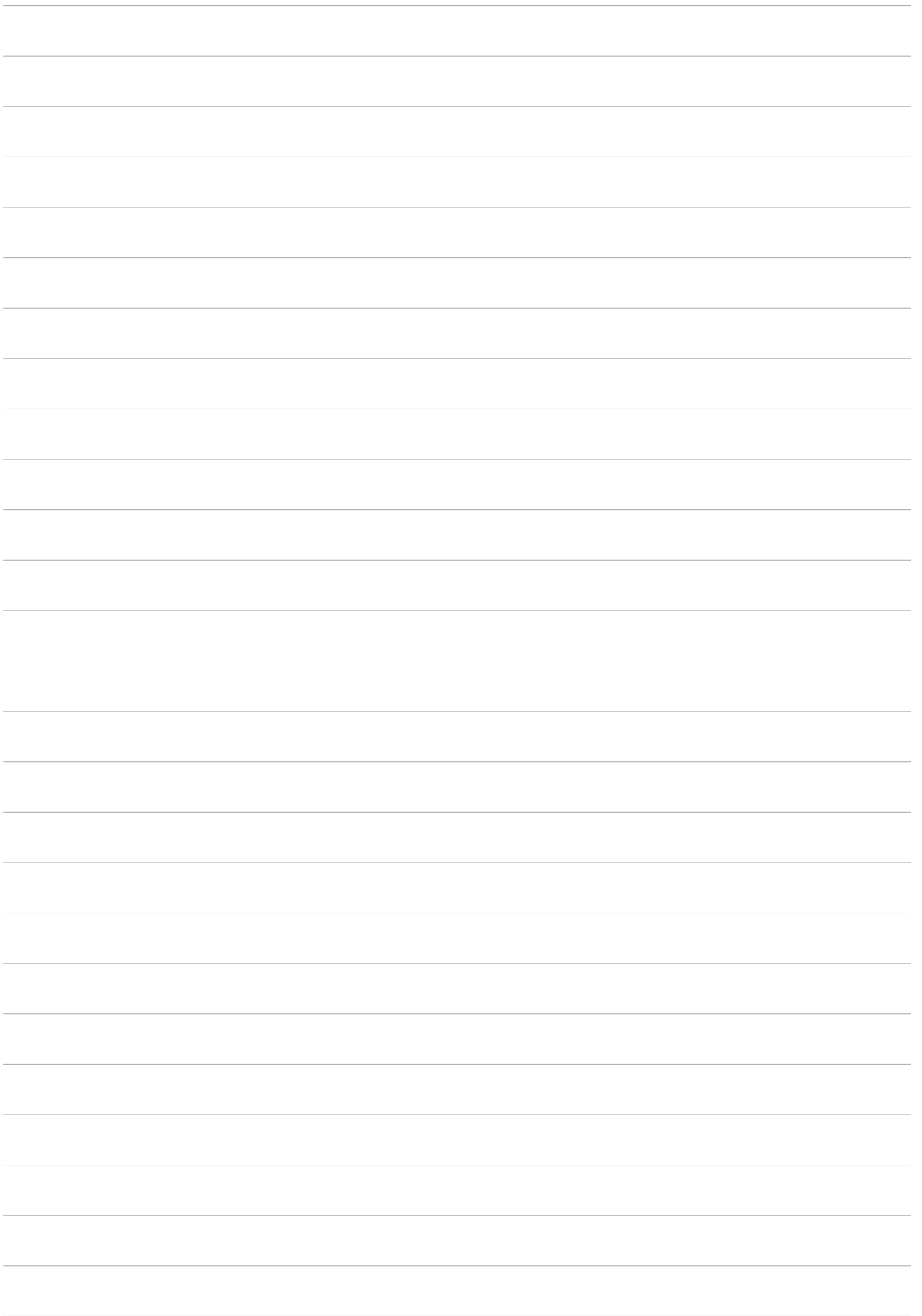



TÜRK STANDARLARI ENSTİTÜSÜ
TÜRK STANDARLARINA UYGUNLUK BELGESİ
TURKISH STANDARDS INSTITUTION
CERTIFICATE OF CONFORMITY TO TURKISH STANDARDS

Markanın Tanımı Description of the Mark
TSE TSE

BELGE NUMARASI
REFERENCE NUMBER OF LICENCE 0238578-TSE-03/01

BELGENİN İLK VERİLİŞ TARİHİ
DATE OF FIRST ISSUE OF LICENCE 05.12.2018

BELGENİN SON GEÇERLİLİK TARİHİ
LICENCE VALID UNTIL 05.12.2019

BELGE SAHİBİ KURULUŞUN ADI
NAME OF THE LICENCE HOLDER ADO PLASTİK VE SERAMİK SANAYİ VE TİCARET ANONİM ŞİRKETİ

BELGE SAHİBİ KURULUŞUN ADRESİ
ADDRESS OF THE LICENCE HOLDER PETROLOŞB MAH. 1. SK. GÜNEYDOĞU TEL ÇİVİ NO:2 MERKEZ ADIYAMAN/TÜRKİYE

ÜRETİM YERİ ADI
NAME OF THE MANUFACTURING PLACE ADO PLASTİK VE SERAMİK SANAYİ VE TİCARET ANONİM ŞİRKETİ

ÜRETİM YERİ ADRESİ
ADDRESS OF THE MANUFACTURING PLACE PETROLOŞB MAH. 1. SK. GÜNEYDOĞU TEL ÇİVİ NO:2 MERKEZ ADIYAMAN / TÜRKİYE

İPTAL EDİLEN BELGE NUMARASI (Varsa)
INDICATION OF SUPERSEDED LICENCE (if any) AVITA

TESCİLLİ TİCARİ MARKASI
REGISTERED TRADE MARK AVITA

İLGİLİ TÜRK STANDARDI
RELATED TURKISH STANDARD TS 799 / Alaturka hela taşılar / 18.02.2015

BELGE KAPSAMI
SCOPE OF LICENCE

"avita" Markalı,
Seramikten mamul alaturka hela taşıları
- Sınıf 1 : Çerçeve yıkamalı
- Tip 2 : Kandırenden Sifonlu

e-İmzalı/e-signed
10.12.2018

Belgelendirme Merkezi Başkanı Adına
HÜSAMETTİN ERBİLGİN
GAZİANTEP BELGELENDİRME MÜDÜR V.

"Bu belge, belgelendiren kurum, üretim yerinin Enstitümüzün belirlediği şartları karşıladığına da gösterir."
"Bu belge için bir kopye talep edilebilir, kopyası veya durumlarını zorunlu olarak e-posta ile gönderilebilir, kopyası ve e-kirisi yapılamaz."
"TSE GAZİANTEP BELGELENDİRME MÜDÜRLÜĞÜ" Adres: 2. Organize Sanayi Bölgesi Hava Sanayi Konutluğu, Bulvarı No:9 Başpaşa/27120 Şehircilik GAZİANTEP / Tel: 0 342 337 55 03 / Pbx: Faks: 0 342 337 55 05
"TSE BELGELENDİRME MERKEZİ BAŞKANLIĞI" Adres: Necatibey Cad. No:112 06100 Beşiktaş/İSTANBUL - Tel: 0 312 416 54 81 / 416 54 27 / Faks: 0 312 416 66 17 / e-posta: irt@tse.org.tr / web: www.tse.org.tr

<https://evrakkontrol.tse.org.tr/BelgeDogrulama.aspx?pr=glmgf> adresinden belgenin doğruluğunu ve geçerliliğini sorgulayınız.



1 / 1



TÜRK STANDARLARI ENSTİTÜSÜ
TÜRK STANDARLARINA UYGUNLUK BELGESİ
TURKISH STANDARDS INSTITUTION
CERTIFICATE OF CONFORMITY TO TURKISH STANDARDS

Markanın Tanımı Description of the Mark
TSE TSE

BELGE NUMARASI
REFERENCE NUMBER OF LICENCE 0238578-TSE-01/01

BELGENİN İLK VERİLİŞ TARİHİ
DATE OF FIRST ISSUE OF LICENCE 17.10.2018

BELGENİN SON GEÇERLİLİK TARİHİ
LICENCE VALID UNTIL 17.10.2019

BELGE SAHİBİ KURULUŞUN ADI
NAME OF THE LICENCE HOLDER ADO PLASTİK VE SERAMİK SANAYİ VE TİCARET ANONİM ŞİRKETİ

BELGE SAHİBİ KURULUŞUN ADRESİ
ADDRESS OF THE LICENCE HOLDER PETROLOŞB MAH. 1. SK. GÜNEYDOĞU TEL ÇİVİ NO:2 MERKEZ ADIYAMAN/TÜRKİYE

ÜRETİM YERİ ADI
NAME OF THE MANUFACTURING PLACE ADO PLASTİK VE SERAMİK SANAYİ VE TİCARET ANONİM ŞİRKETİ

ÜRETİM YERİ ADRESİ
ADDRESS OF THE MANUFACTURING PLACE PETROLOŞB MAH. 1. SK. GÜNEYDOĞU TEL ÇİVİ NO:2 MERKEZ ADIYAMAN / TÜRKİYE

İPTAL EDİLEN BELGE NUMARASI (Varsa)
INDICATION OF SUPERSEDED LICENCE (if any) AVITA

TESCİLLİ TİCARİ MARKASI
REGISTERED TRADE MARK AVITA

İLGİLİ TÜRK STANDARDI
RELATED TURKISH STANDARD TS EN 997-A1 / Tek parça ve takım klozetler - Sifonlu / 23.10.2015

BELGE KAPSAMI
SCOPE OF LICENCE

"avita" MARKALI
1-SERAMİKTE MAMUL, SINIF 1, REZERVUARLIZ, YIKAMA DÜZENECİ DOĞRUDAN BOŞALTIMLI REZERVUAR TIP-A OLAN, ANMA YIKAMA SUYU HACMI 6 LİTRE, TEK YIKAMA FONKSİYONLU, AYAKLI TAKIM KLOZET
2-SERAMİKTE MAMUL, SINIF 1, REZERVUARSIZ, YIKAMA DÜZENECİ DOĞRUDAN BOŞALTIMLI REZERVUAR TIP-A OLAN, ANMA YIKAMA SUYU HACMI 6 LİTRE, TEK YIKAMA FONKSİYONLU, ASMA, TEK PARÇA KLOZET

e-İmzalı/e-signed
22.10.2018

Belgelendirme Merkezi Başkanı Adına
HÜSAMETTİN ERBİLGİN
GAZİANTEP BELGELENDİRME MÜDÜR V.

"Bu belge, belgelendiren kurum, üretim yerinin Enstitümüzün belirlediği şartları karşıladığına da gösterir."
"Bu belge için bir kopye talep edilebilir, kopyası veya durumlarını zorunlu olarak e-posta ile gönderilebilir, kopyası ve e-kirisi yapılamaz."
"TSE GAZİANTEP BELGELENDİRME MÜDÜRLÜĞÜ" Adres: 2. Organize Sanayi Bölgesi Hava Sanayi Konutluğu, Bulvarı No:9 Başpaşa/27120 Şehircilik GAZİANTEP / Tel: 0 342 337 55 03 / Pbx: Faks: 0 342 337 55 05
"TSE BELGELENDİRME MERKEZİ BAŞKANLIĞI" Adres: Necatibey Cad. No:112 06100 Beşiktaş/İSTANBUL - Tel: 0 312 416 54 81 / 416 54 27 / Faks: 0 312 416 66 17 / e-posta: irt@tse.org.tr / web: www.tse.org.tr

<https://evrakkontrol.tse.org.tr/BelgeDogrulama.aspx?pr=glmgf> adresinden belgenin doğruluğunu ve geçerliliğini sorgulayınız.



1 / 1



TÜRK STANDARLARI ENSTİTÜSÜ
TÜRK STANDARLARINA UYGUNLUK BELGESİ
TURKISH STANDARDS INSTITUTION
CERTIFICATE OF CONFORMITY TO TURKISH STANDARDS

Markanın Tanımı Description of the Mark
TSE TSE

BELGE NUMARASI
REFERENCE NUMBER OF LICENCE 0238578-TSE-02/01

BELGENİN İLK VERİLİŞ TARİHİ
DATE OF FIRST ISSUE OF LICENCE 17.10.2018

BELGENİN SON GEÇERLİLİK TARİHİ
LICENCE VALID UNTIL 17.10.2019

BELGE SAHİBİ KURULUŞUN ADI
NAME OF THE LICENCE HOLDER ADO PLASTİK VE SERAMİK SANAYİ VE TİCARET ANONİM ŞİRKETİ

BELGE SAHİBİ KURULUŞUN ADRESİ
ADDRESS OF THE LICENCE HOLDER PETROLOŞB MAH. 1. SK. GÜNEYDOĞU TEL ÇİVİ NO:2 MERKEZ ADIYAMAN/TÜRKİYE

ÜRETİM YERİ ADI
NAME OF THE MANUFACTURING PLACE ADO PLASTİK VE SERAMİK SANAYİ VE TİCARET ANONİM ŞİRKETİ

ÜRETİM YERİ ADRESİ
ADDRESS OF THE MANUFACTURING PLACE PETROLOŞB MAH. 1. SK. GÜNEYDOĞU TEL ÇİVİ NO:2 MERKEZ ADIYAMAN / TÜRKİYE

İPTAL EDİLEN BELGE NUMARASI (Varsa)
INDICATION OF SUPERSEDED LICENCE (if any) AVITA

TESCİLLİ TİCARİ MARKASI
REGISTERED TRADE MARK AVITA

İLGİLİ TÜRK STANDARDI
RELATED TURKISH STANDARD TS EN 14688 / Sağlık gereçleri - Lavabolar - İşlevsel gereçler ve deney yöntemleri / 23.10.2015

BELGE KAPSAMI
SCOPE OF LICENCE

(CL 20) SINIF 20 DEBİSİ \geq 0,20 L/S OLAN TAŞMA TERTİBATLI ASMA TIP LAVABO, SİRLİ SERAMİKTE MAMUL, EL YIKAMA LAVABOSU

(CL 20) SINIF 20 DEBİSİ \geq 0,20 L/S OLAN TAŞMA TERTİBATLI KONSOLA OTURAN TIP LAVABO , SİRLİ SERAMİKTE MAMUL , EL YIKAMA LAVABOSU

(CL 20) SINIF 20 DEBİSİ \geq 0,20 L/S OLAN TAŞMA TERTİBATLI AYAKLI LAVABO, SİRLİ SERAMİKTE MAMUL, EL YIKAMA LAVABOSU

e-İmzalı/e-signed
22.10.2018

Belgelendirme Merkezi Başkanı Adına
HÜSAMETTİN ERBİLGİN
GAZİANTEP BELGELENDİRME MÜDÜR V.

"Bu belge, belgelendiren kurum, üretim yerinin Enstitümüzün belirlediği şartları karşıladığına da gösterir."
"Bu belge için bir kopye talep edilebilir, kopyası veya durumlarını zorunlu olarak e-posta ile gönderilebilir, kopyası ve e-kirisi yapılamaz."
"TSE GAZİANTEP BELGELENDİRME MÜDÜRLÜĞÜ" Adres: 2. Organize Sanayi Bölgesi Hava Sanayi Konutluğu, Bulvarı No:9 Başpaşa/27120 Şehircilik GAZİANTEP / Tel: 0 342 337 55 03 / Pbx: Faks: 0 342 337 55 05
"TSE BELGELENDİRME MERKEZİ BAŞKANLIĞI" Adres: Necatibey Cad. No:112 06100 Beşiktaş/İSTANBUL - Tel: 0 312 416 54 81 / 416 54 27 / Faks: 0 312 416 66 17 / e-posta: irt@tse.org.tr / web: www.tse.org.tr

<https://evrakkontrol.tse.org.tr/BelgeDogrulama.aspx?pr=glmgf> adresinden belgenin doğruluğunu ve geçerliliğini sorgulayınız.



1 / 1



www.avitaseramik.com.tr

www.avitaseramik.com.tr



ADO Seramik Plastik San. ve Tic. A.Ş.
Organize Sanayi Bölgesi
7. Cadde 1. Sokak No: 2
ADİYAMAN / TURKEY

Tel +90 416 227 16 46



International
Organization for
Standardization